

# HORIBA

Process & Environmental

Explosion-proof INFRARED ANALYZER

**EIA-51d/51p**  
**TIA-51d/51p**

Explosion-proof THERMAL CONDUCTIVITY ANALYZER

**TCA-51d/51p**

Explosion-proof MAGNETOPNEUMATIC OXYGEN ANALYZER

**MPA-51d/51p**

Explosion-proof PARAMAGNETIC OXYGEN ANALYZER

**PMA-51d**



# Advanced technologies that provide safety. An explosion-proof gas analyzer is born.

The 51 series advanced explosion-proof analyzers include HORIBA's extensive experience and specialized know-how to provide the safety, reliability, and accuracy you demand in analyzing flammable gases or operating in explosive environments. To realize the highest levels of safety and operability, the 51 series offers an intuitive interface with a clearly visible display. The analyzers' long term reliability and your confidence are ensured by full compatibility with IEC 60079 standards. The extensive line-up for the 51 series covers a wide range of applications including infrared gas analyzers for general-purpose processes and models for use with oxygen and hydrogen. The HORIBA 51 series meets your gas analysis needs in environments where safety, reliability, and accuracy are always your priorities.



**New designs and unique concepts  
define the next generation of standards**

**Focused on functionality**

- **Meets diverse gas analysis requirements**
- **Offers a clearly visible and easy-to-operate user interface**
- **Compatible with IEC 60079 standards and communication functions**

## Hydrogen explosion-proof models

Building on the HORIBA legacy of safety, reliability, and accuracy of the 31 series, the new 51 series enhances explosion-proof specs to the level of IIB + H<sub>2</sub>.

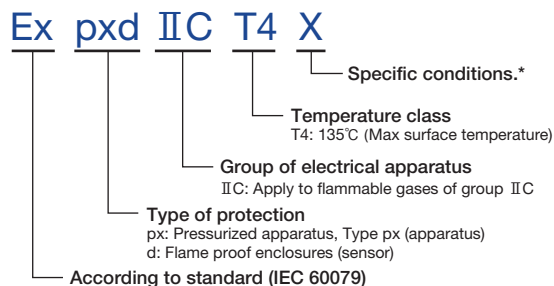
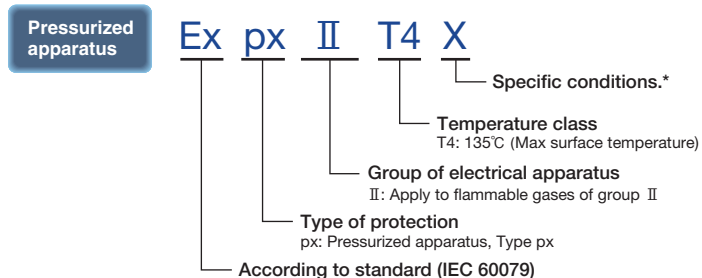
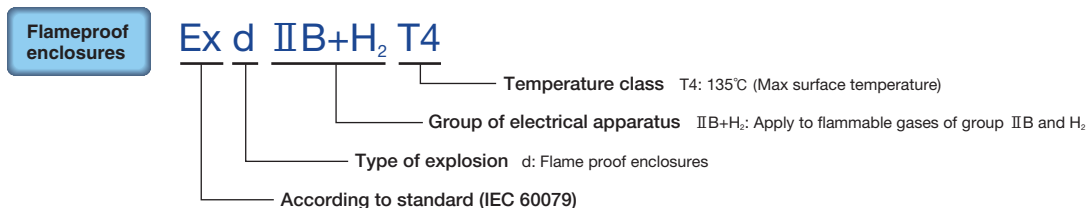

\*The apparatus pressurized internally is 50 Pa higher than measuring gas pressure.

# Principle

## EIA-51d/51p · TIA-51d/51p

### ■ Non-dispersive infrared (NDIR) analyzer (interference correction type)

#### Conceptual diagram

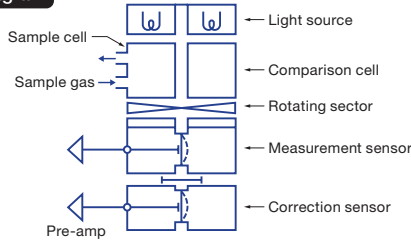

#### Measurement principle

"Interference correction" is an original method based on NDIR analysis that ensures extremely high accuracy even in the case of samples containing large amounts of interfering compounds.

The interference correction combines a measurement sensor with a correction sensor positioned in parallel in the same optical path. This significantly reduces the effects of:

- interfering gases in the sample gas;
- vibrations and other external disturbances; and
- drift resulting from deterioration of the light source and cell components.

## TCA-51d/51p

### ■ Heat conductivity type

#### Conceptual diagram

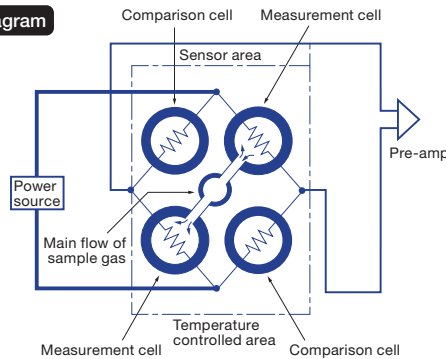

#### Measurement principle

Gas concentration is measured using the differences in heat conductivity unique to specific gases. The sensor area forms a Wheatstone bridge using measurement cells and comparison cells containing hot wires made from platinum and other materials. The sample gas flows into the measurement cell as a result of diffusion, and a base gas (generally nitrogen or air) is sealed inside the comparison cell.

The hot wires are heated by a constant current. If the sample gas contains a gas with a heat conductivity differing from that of the standard gas in the comparison cell, then the temperature of the hot wires on the measurement side changes, and this in turn changes the resistance depending on the composition of the sample gas. This change in resistance is converted into a concentration signal for the gas being measured, based on the change in the unbalanced voltage of the Wheatstone bridge.

## MPA-51d/51p

### ■ Magnetic pressure analyzer (pressure sensor / magnetic force type)

#### Conceptual diagram

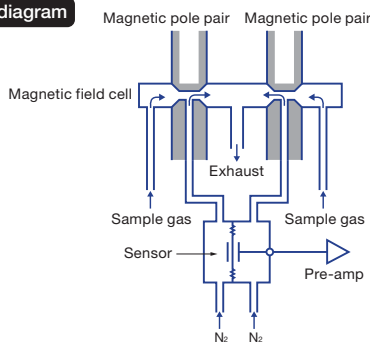

#### Measurement principle

Because oxygen has extremely strong paramagnetic characteristics, if there is any oxygen in a heterogeneous magnetic field, then the oxygen is drawn toward the stronger magnetic field, and the pressure in that area changes (increases).

The change in pressure is represented by the following formula.

$$\Delta p = 1/2 H^2 \times X \times C$$

$\Delta p$ : change in pressure; H: Strength of magnetic field; X: Magnetic susceptibility of paramagnetic gas; C: Temperature of paramagnetic gas

This pressure increase is drawn out of the magnetic field using a non-magnetic comparison gas (nitrogen), and the pressure change is detected by a sensor and converted into an electrical signal. The electromagnets are excited alternately to derive and transmit a stable signal, which is processed as an alternating signal. For this reason, if there is no oxygen in the sample gas, the signal is zero, so there is no zero drift, and the signal remains extremely stable over long periods of time. Furthermore, the output is linear in reference to the oxygen concentration, so concentration can be measured across a very broad range.

## PMA-51d

### ■ Magnetic dumbbell (dumbbell-shaped magnet type)

#### Conceptual diagram

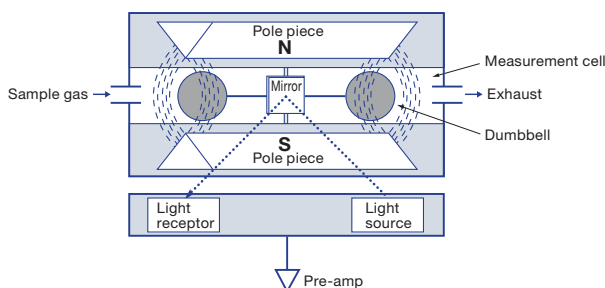

#### Measurement principle

Because oxygen has extremely strong paramagnetic characteristics, if there is any oxygen in a heterogeneous magnetic field, then the oxygen is drawn toward the stronger magnetic field.

In the sensor area, a glass dumbbell with a mirror attached is hung horizontally using platinum wires. When oxygen passes through the sensor area, the dumbbell is pushed out by the magnetic field effects described above.

The change in pressure is represented by the following formula.

$$F = (X1 - X2) \times V \times H$$

F: Force acting on the dumbbell; X1: Magnetic susceptibility of the dumbbell; X2: Magnetic susceptibility of the surrounding gas; V: Volume of the test body; H: Strength of the magnetic field

As the dumbbell rotates, the position of the reflected light reaching the photocell (the light receptor) changes. Reverse torque is then added to the dumbbell through a feedback system to return the dumbbell to its original position.

Because this torque is linear in reference to the oxygen concentration, the torque value is output as the oxygen concentration.

## ■ Specification

Model		EIA-51d	EIA-51p	TIA-51d	TIA-51p
Type of protection		Exd II B+H <sub>2</sub> T4	Exp II T4X	Exd II B+H <sub>2</sub> T4	Exp II T4X
Flameproof enclosures		●		●	
Pressurized apparatus			●		●
Measurement method		NDIR			
Component		CO, CO <sub>2</sub> , CH <sub>4</sub> , etc.*1			
Measurement range	Minimum range	0 to 0.11 vol% (Depends on the component)		0 to 50 ppm (Depends on the component)	
	Maximum range	0 to 100 vol% (Depends on the component)		0 to 2000 ppm (Depends on the component)	
	Optional	100-90 to 50 vol% (Depends on the component)		0-20 to within less than 50 ppm (Depends on the component)	—
Range Ratio		—		—	
Performance	Repeatability	Standard range	Zero : ±0.5% of full scale		Zero : ±0.5% of full scale
		Optional range	Span : ±0.5% of full scale		Span : ±0.5% of full scale
	Linearity	Standard range	Zero : ±0.5% of full scale		Zero : ±1.0% of full scale
		Optional range	Span : ±0.5% of full scale		Span : ±1.0% of full scale
	Drift*2	Standard range	Zero : ±2.0% of full scale/week		Span : ±2.0% of full scale/week
		Optional range	Varies by specification		
Response time (from in let of analyzer)				T90 within 20 seconds T90 within 40 seconds (TIA optional range)	
Sample gas Condition	Gas composition	Flameproof enclosures	O <sub>2</sub> : 21% or less, no mist, no dust The hazardous must be equivalent or less with electrical apparatus group II B, gas and vapor-air mixture corresponding to temperature code T4.		
		Pressurized apparatus	O <sub>2</sub> : 21% or less, no mist, no dust The ignition temperature must be equivalent or less with electrical apparatus of gas and vapor-air mixture corresponding to temperature code T4.		
	Pressure	Over 1.98 kPa			
	Flow rate	Approx. 500 mL/min.			
	Temperature	Ambient temperature			
	Exhaust	Atmosphere pressure			
Materials in contact with sample gas		SUS304, SUS316, FKM, CaF <sub>2</sub> , Au, etc.			
Calibration method		Standard : Manual correction, Option : Automatic correction			
Analog output		DC 4 to 20 mA (DC 0 to 16 mA/0 to 20 mA, DC0 to 1 V/0 to 5 V/1 to 5 V/0 to 10 V optional), 1 ch			
	Alarm setting	Arbitrary setting is available with span range from -10% to +110% of output for current and voltage. Negative output values set to 0.			
Contact Input-output (option)		6 channels			
Digital connection (option)	Interface	RS-485			
	Protocol	Modbus-RTU			
	Communication speed	Selected from 19200 bps/9600 bps/4800 bps/2400 bps/1200 bps			
Environment conditions	Location	Indoors			
	Operational Temperature	-5 to 40 °C (away from direct sunlight and radiant heat)			
	Humidity	90% or less			
	Vibration	Avoid large vibration sources (less than 100 Hz; 0.3 m/s <sup>2</sup> )			
Utility	Protective gas for Pressurized apparatus composition	Gas composition : N <sub>2</sub> , Gas pressure : 196 to 690 kPa, Gas flow rate : 10 L/min. (when purging), 500 mL/min. (when operating) De			

\*1 Consult HORIBA for measurement of the other components. \*2 Guaranteed at normal ambient temp. ±5°C

## ■ Recommended Measuring Ranges

	EIA-51d/51p		TIA-51d/51p	
	Min. Range	Max. Range	Min. Range	Max. Range
CO	0 to 0.21%	0 to 100%	0 to 50 ppm	0 to 2000 ppm
CO <sub>2</sub>	0 to 0.11%	0 to 100%	0 to 50 ppm	0 to 1000 ppm
CH <sub>4</sub>	0 to 0.21%	0 to 100%	0 to 50 ppm	0 to 2000 ppm
C <sub>3</sub> H <sub>8</sub>	0 to 0.051%	0 to 100%	0 to 50 ppm	0 to 500 ppm
NO	0 to 0.21%	0 to 100%	0 to 100 ppm	0 to 2000 ppm
SO <sub>2</sub>	0 to 0.051%	0 to 100%	0 to 100 ppm	0 to 500 ppm

Consult HORIBA for applications other than those listed above.

TCA-51d	TCA-51p	MPA-51d	MPA-51p	PMA-51d
Exd II B+H <sub>2</sub> T4	Expxd II T4X	Exd II B+H <sub>2</sub> T4	Exp II T4X	Exd II B+H <sub>2</sub> T4
●	●	●	●	●
Thermal conductivity		Magnetopneumatic		Paramagnetic
H <sub>2</sub>		O <sub>2</sub>		
0 to 10 vol%		0 to 5 vol%		
0 to 100 vol%		0 to 25 vol%		
0-1 to within less than 10 vol%    100-90 to 50 vol%		0-1 to within less than 5 vol%		—
—		Max.1:25    Max.4 range		Max.1: 5
Zero : ±1.0% of full scale		Zero : ±0.5% of full scale		Zero : ±0.1 vol% O <sub>2</sub>
Span : ±1.0% of full scale		Span : ±0.5% of full scale		Span : ±0.1 vol% O <sub>2</sub>
Zero : ±1.0% of full scale		Zero : ±1.0% of full scale		—
Span : ±1.0% of full scale		Span : ±1.0% of full scale		—
		Zero : ±1.0% of full scale/week		Zero : ±0.05 vol% O <sub>2</sub> /week
		Span : ±2.0% of full scale/week		Span : ±0.05 vol% O <sub>2</sub> /week
Varies by specification		Zero : ±1.0% of full scale/week		Varies by specification
		Span : ±3.0% of full scale/week		
T90 within 20 seconds				

temperature code T4, and Hydrogen-air mixture.

O <sub>2</sub> : 21% or less, no mist, no dust The hazardous must be equivalent or less with electrical apparatus of group II C gas and vapor-air mixture corresponding to temperature code T4.	O <sub>2</sub> : 21% or less, no mist, no dust The ignition temperature must be equivalent or less with electrical apparatus of gas and vapor-air mixture corresponding to temperature code T4.
	14.7 to 24.5 kPa
	Approx . 1.5L/min
	Over 1.98 kPa
	Approx . 300mL/min
SUS304, SUS316, FKM, glass, SiO <sub>2</sub> , Au	SUS304, SUS316, FKM
	SUS304, SUS316, Pt, glass, FKM

zero.

Low Point : -30°C Saturated or less

## System configuration

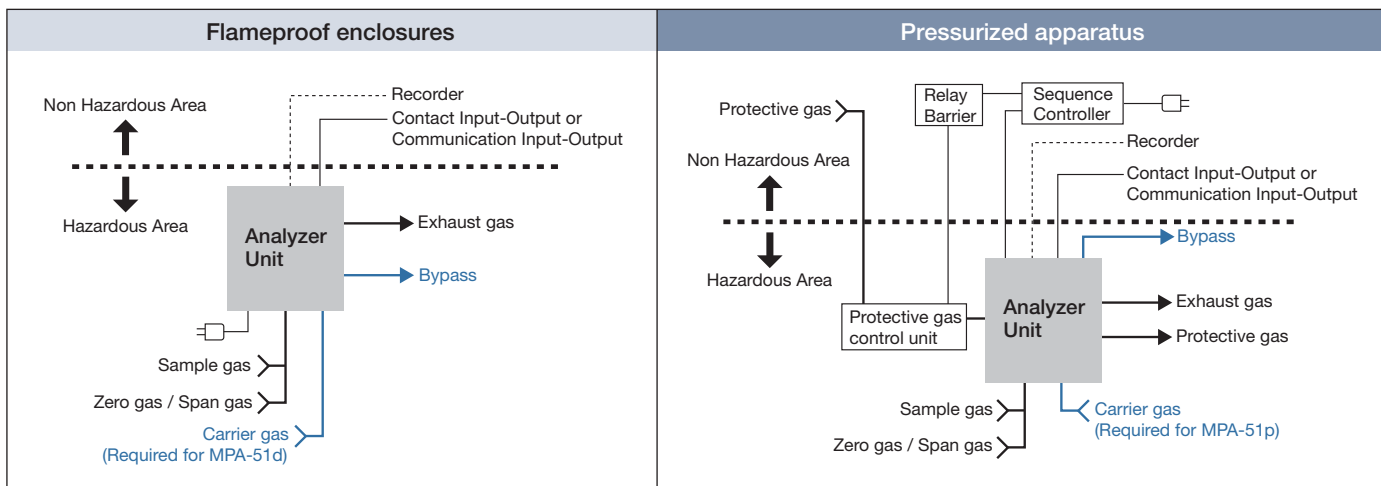

■ Dimensional Outlines unit: mm

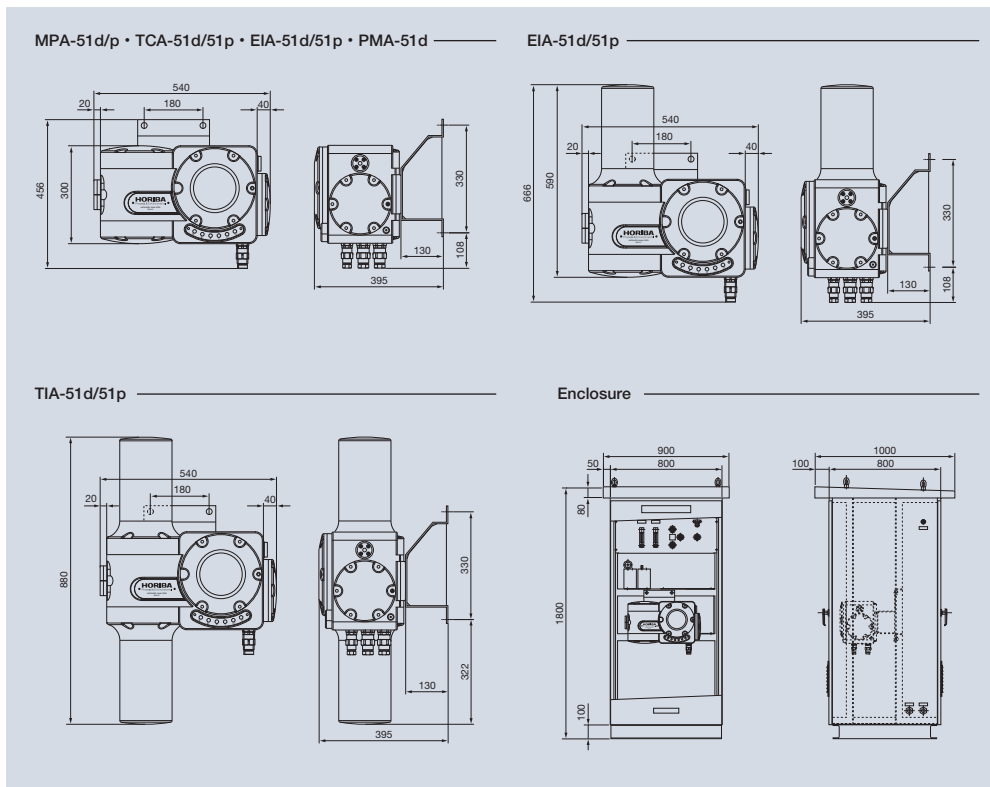

■ Peripheral instruments  
(Required for Pressurized apparatus)

Sequence Controller

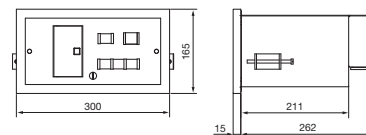

Relay Barrier

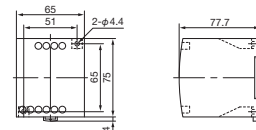

Protective gas control unit

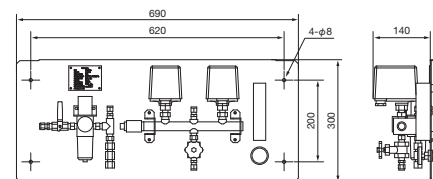

**IMS** The HORIBA Group adopts IMS (Integrated Management System) which integrates Quality Management System ISO9001, Environmental Management System ISO14001, and Occupational Health and Safety Management System OHSAS18001. We have now integrated Business Continuity Management System ISO22301 in order to provide our products and services in a stable manner, even in emergencies.



Please read the operation manual before using this product to assure safe and proper handling of the product.

- The specifications, appearance or other aspects of products in this catalog are subject to change without notice.
- Please contact us with enquiries concerning further details on the products in this catalog.
- The color of the actual products may differ from the color pictured in this catalog due to printing limitations.
- It is strictly forbidden to copy the content of this catalog in part or in full.
- The screen displays shown on products in this catalog have been inserted into the photographs through compositing.
- All brand names, product names and service names in this catalog are trademarks or registered trademarks of their respective companies.

<http://www.horiba.com> e-mail: [info@horiba.co.jp](mailto:info@horiba.co.jp)

**HORIBA, Ltd. Japan**

**Head Office**  
2 Miyahogashi, Kisshoin, Minami-ku, Kyoto, Japan  
Phone: 81 (75) 313-8121 Fax: 81 (75) 321-5725

**HORIBA (China) Trading Co., Ltd. China**

**Shanghai**  
Unit D, 1F, Building A, Synnex International Park, 1068 West Tianshan Road, Shanghai, 200335, China  
Phone: 86 (21) 6289-6060 Fax: 86 (21) 6289-5553

**Beijing**  
12F, Metropolis Tower, No.2, Haidian Dong 3 Street, Beijing, 100080, China  
Phone: 86 (10) 8567-9966 Fax: 86 (10) 8567-9066

**HORIBA Korea Ltd. Korea**

10, Dogok-Ro, 6-Gil, Gangnam-Gu, Seoul-Si, 06259, Korea  
Phone: 82 (2) 753-7911 Fax: 82 (2) 756-4972

**HORIBA Instruments (Singapore) Pte Ltd. Singapore**

3 Changi Business Park Vista #01-01 Akzonobel House, Singapore 486051  
Phone: 65 (6) 745-8300 Fax: 65 (6) 745-8155

**HORIBA Vietnam Co., Ltd. Vietnam**

Unit 10, 4 Floor, CMC tower, Duy Tan Street, Dich Vong Hau Ward, Cau Giay District, Hanoi, Vietnam  
Phone: 84 (4) 3795-8552 Fax: 84 (4) 3795-8553

**HORIBA (Thailand) Ltd. Thailand**

**East Office**  
850 / 7 Soi Lat Krabang 30 / 5, Lat Krabang Road, Lat Krabang, Bangkok 10520, Thailand  
Phone: 66 (0) 2734 4434 Fax: 66 (0) 2734 4438

**PT HORIBA Indonesia Indonesia**

Jl. Jalur Sutera Blok 20A, No.16-17, Kel. Kunciran, Kec. Pinang Tangerang-15144, Indonesia  
Phone: 62 (21) 3044-8525 Fax: 62 (21) 3044-8521

**HORIBA India Private Limited India**

**Delhi**  
246, Okhla Industrial Estate, Phase 3 New Delhi-110020, India  
Phone: 91 (11) 4646-5000 Fax: 91 (11) 4646-5020

**Pune**  
502, 5th Floor, Purushottam Plaza, Baner Road, Baner, Pune-411045 India  
Phone: 91 (20) 4076-6000 Fax: 91 (20) 4076-6010

**Bangalore**  
Kamadhenu, No.17 / 1 - 32, Bannerghatta Road, Audugodi Bangalore-560030 India  
Phone: 91 (80) 22210071

**HORIBA Instruments Inc. USA**

**Head Office**  
9755 Research Drive, Irvine, CA 92618, U.S.A.  
Phone: 1 (949) 250-4811 Fax: 1 (949) 250-0924

**Alvin, TX**  
5318 W.FM517 Rd, Alvin, TX 77511, U.S.A  
Phone: 1 (281) 482-4334 Fax: 1 (281) 614-0303

**HORIBA Instruments Brazil, Ltda. Brazil**

**Head Office**  
Rua:Presbitero Plinio Alves de Souza, 645, Loteamento Polo Multivias Barrio Medeiros-Jundiai Sao Paulo CEP 13.212-181 Brazil  
Phone: 55 (11) 2923-5400 Fax: 55 (11) 2923-5490

**HORIBA France Sarl France**

12, Av des Tropiques Hightec Sud, F-91955 Les Ulis, France  
Phone: 33 (1) 69-29-96-23 Fax: 33 (1) 69-29-95-77

**HORIBA UK Limited UK**

**Northampton**  
Kyoto Close Moulton Park, Northampton NN3 6FL, UK  
Phone: 44 (1604) 542-500 Fax: 44 (1604) 542-699

**HORIBA Europe GmbH Germany**

**Head Office**  
Hans-Mess-Str.6 D-61440 Oberursel Germany  
Phone: 49 (6172) 1396-0 Fax: 49 (6172) 1373-85

**Leichlingen**  
Julius-kronenberg Str.9 D-42799 Leichlingen Germany  
Phone: 49 (2175) 8978-0 Fax: 49 (2175) 8978-50

**HORIBA Czech Czech**

Prumyslova 1306 / 7, CZ-10200, Praha 10, Czech Republic  
Phone: 420 (2) 460-392-65

**HORIBA (Austria) GmbH Austria**

Kaplanstrasse 5 A-3430 Tulln, Austria  
Phone: 43 (2272) 65225 Fax: 43 (2272) 65230